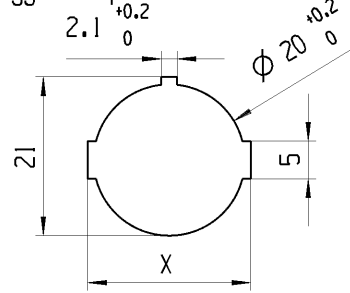

© THIS DRAWING IS THE EXCLUSIVE PROPERTY OF MARQUARDT. WITHOUT THEIR CONSENT IT MAY NOT BE REPRODUCED OR GIVEN TO THIRD PARTIES.

CONFIDENTIAL

VERTRAULICH

© Alle Rechte bei Marquardt, auch fuer den Fall von Schutzrechtsanmeldungen. Jede Verfertigungsbefugnis, wie Kopier- und Weitergaberecht, bei uns.

A	1	2	3	4
	Empfohlener Plattenausschnitt suggested panel cutout	Plattendicke panel thickness	X	
		0.75-1.25 1.25-2.00 2.00-3.00	21.2 -0.1 21.4 -0.1 21.8 -0.1	

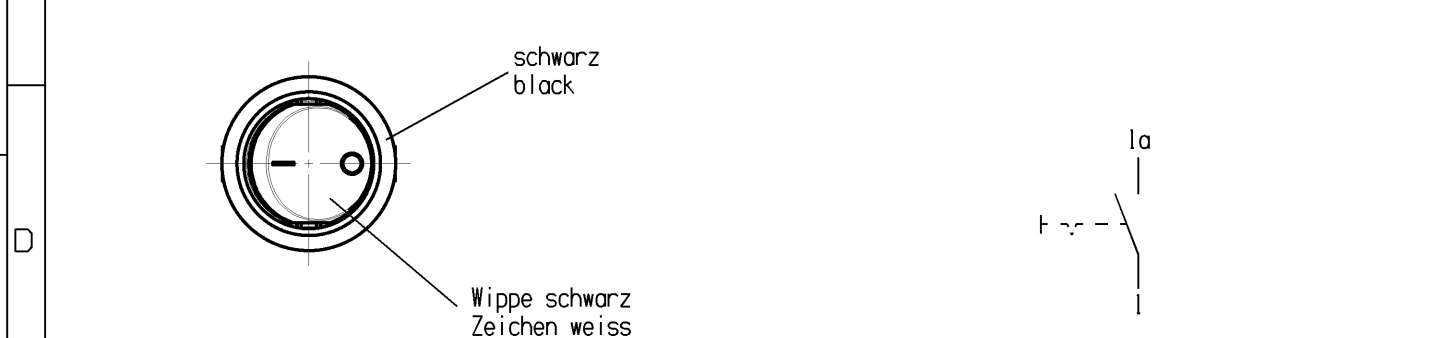
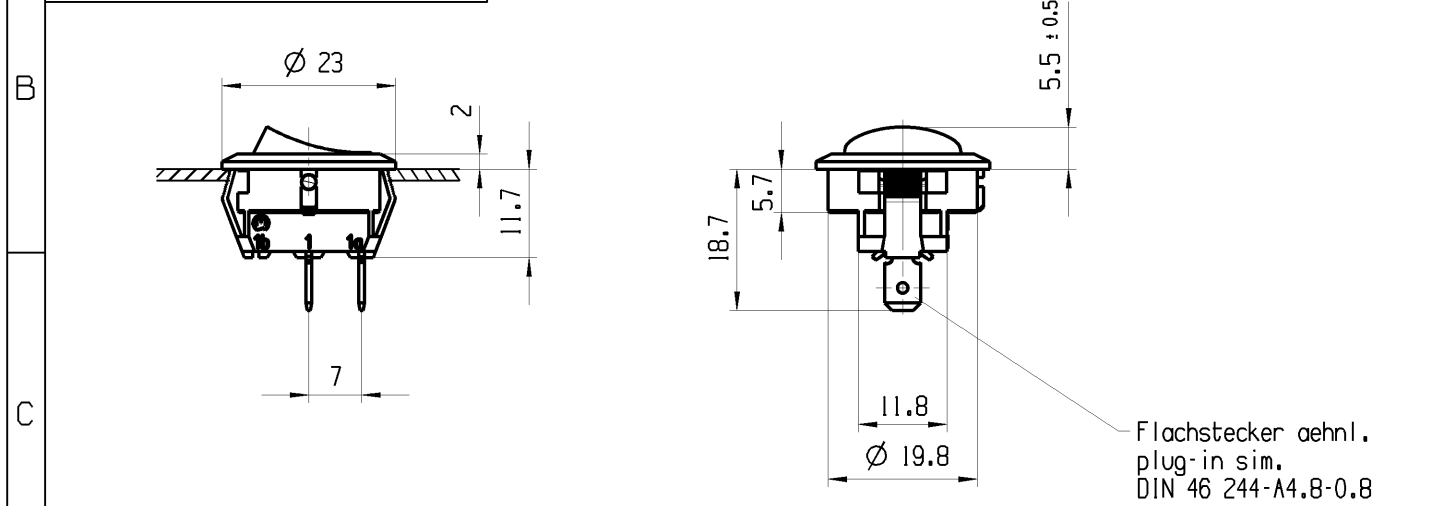

Aufschrift
Marking

Ⓜ
18..
8(18)/250~5E4
12(14)/250~
5/70A 250V~
T100/55  05

Aufschriftbeschreibung
Marking description

R149  15



R149: 15A 125-250V AC
3/4 HP 125V AC
1 1/2 HP 250V AC

Ausschalter 1-polig
Fuer Gerate der Klasse II geeignet
Wippe und Gehaeuse V0-Material

SPST
suitable for appliances of class II
rocker and housing V0-material

G=Konform nach IEC 60335-1:2001 Kap.30
G=matching IEC 60335-1:2001 clause 30

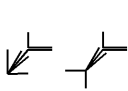
Auf Verpackung/on box: G

fuer Form und Lage FOR SHAPE AND LOC.	⊙ =	Allgemeintoleranzen UNTOLERANCED DIMENSIONS				Pause COPY	Blatt SHEET 01	TYP K	Zeichn./DRAWING NO. 18811108	Index c
	fuer Winkel FOR ANGLE ± 2		PROJEKTION 	Abmasse und Nennmassbereiche Angaben in mm	Loenge LENGTH					
			ALL DIMENSIONS ARE IN MILLIMETRES	0-6 ± 0.2	± 0.2			GERAETESCHALTER		
				>6-15 ± 0.4	± 0.4			appliance switch		
				>15-30 ± 0.4	± 0.4			Ersatz fuer/REPLACEMENT OF V06006120		
				>30-70 ±				MARQUARDT		
				>70-120 ±				RELEASED/FREIGEgeben 2010/Sep/30		
				>120-200 ±	± 10%					
c	69880	07/26/10	LX					CAD: NX v4.0		
b	54873	10/25/07	LX					gez./DRAWN BY 02/09/06 RA		
a	45331	02/17/06	MUT					gepr./CHECKED BY		
	46262	02/14/06	RA							
Ausg. ISSUE	Aenderung REVISION	gez. DRAWN BY	Ausg. ISSUE	Aenderung REVISION	gez. DRAWN BY					